

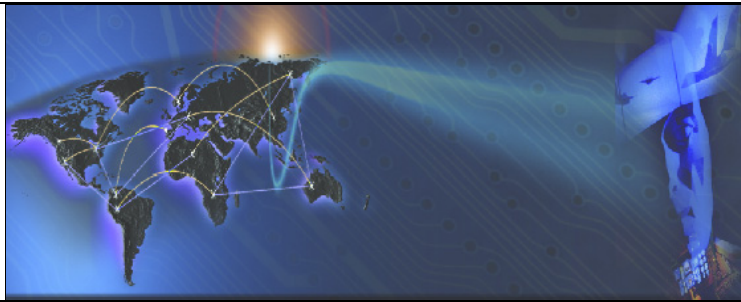

**COMPRO Computer Services, Inc.**  
 Tel: (800) 936-2673  
 www.compro.net



## HUMAN INTERFACE DATA ACQUISITION SYSTEM (HIDAS™)

### FEATURES

- Built-in Features for Lamp Test and Backlit Panel Dimming
- High Signal Count per Board Simplifies Cabling
- Custom Serial Interfaces for Typical Cockpit LED & 7-Segment Displays

### BENEFITS

- Easy Fault Isolation & Troubleshooting
- Token Ring Design Ensures Reliable Deterministic Data Acquisition
- Flexible and Low-Cost FPGA Design
- Modular Design is Easily Expandable
- Separates Logical Software Engineering and Physical Device Considerations

COMPRO's Human Interface Data Acquisition System (HIDAS™) is a low-cost, flexible, data acquisition system for connecting physical switches, dials, potentiometers, encoders, lamps, displays, gauges, and other custom devices to a PC or workstation via a Peripheral Component Interconnect (PCI) bus interface controller.

The HIDAS™ was developed for applications like flight simulators where a human is in the loop controlling or viewing the connected devices. The HIDAS™ uses Field Programmable Gate Array (FPGA) technology, making it quickly adaptable for custom interfaces.

HIDAS™ creates a network of PCI bus Host Interface Controller(s), each wired to one or more node boards via unshielded, twisted pair cabling. Node boards are in turn wired to physical components.

Node boards can be hundreds of feet apart from each other and from the controller. A HIDAS™ system is cost effective for environments with as few as 10 devices up to 1000s of devices.

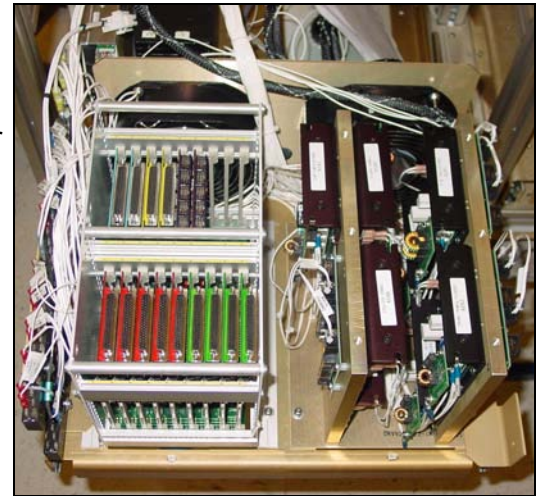

The associated Linux® HIDAS™ interface software provides calibration, diagnostics, engineering unit conversion, and easy-to-use test and checkout of complex I/O. This separates the concerns of the physical hardware from the control and algorithms of the application code.

### HIDAS™ Boards

The HIDAS™ consists of 1 to 4 PCI Host Interface Controller (HIC) boards that are mounted in a Linux®-based PC. A HIC board connects to up to 128 node boards via a 2 MBit/sec serial bus using CAT5 UTP cabling. There are 5 types of HIDAS™ node boards, which are color-coded for easy identification:

- Transistor-Transistor Logic (TTL) board
- Display Driver board
- Analog Input board
- Analog Output board
- Custom serial board used for LCD/LED displays and specialty aircraft serial interfaces



Node boards have a Euroboard 3U form factor (100 cm x 160 cm) and are typically mounted in 9-slot HIDAS backplanes installed in 3U VME/Euroboard racks. Backplanes are passive boards that simplify mounting, data link connections, and power distribution. Backplane and rack configuration can be custom or can be configured 3 backplanes across (27 node boards) to mount in standard 19-inch (48.26 cm) racks.

The modular architecture of the HIDAS™ simplifies and standardizes the software interface and the device wiring, thus reducing the time and risk of hardware-software integration.



**HIDAS (Cont'd)**

**Ring Operation and Software**

HIDAS™ node boards/backplanes are connected serially to and from the system's Host Interface Controller (HIC) forming a ring. Each node board in the ring uses a token ring style protocol to provide a deterministic data rate on the bus.

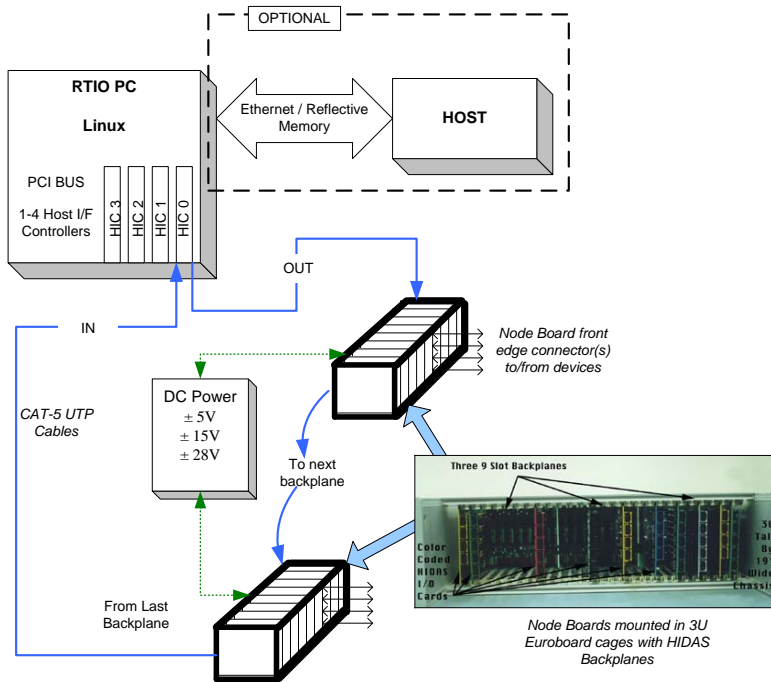

Messages originate from software and are transmitted to the first node board in the ring via the HIC.

- If the message is addressed to this node, the node responds to the command in the message, modifies the message as required, and re-transmits the message to the next node in the ring.
- If the message is not addressed to a node board, then it transmits the message on to the next node board without modification.

A message ultimately makes its way completely around the ring and back to the HIC, where the HIC moves the collected data and status into shared memory for application software use.

The HIDAS™ interface software includes built-in test functions that execute when HIDAS™ is initialized. The built-in test verifies ring continuity and link controller memory integrity.

Each node board has one or more LEDs to indicate power on and data clock received from the transmission link. If the ring breaks or a node board fails, subsequent boards will self generate a data packet after a period of no inbound activity.

This feature, in conjunction with the LEDs, allows fault isolation to one of two boards. Using diagnostic software on the host PC, a technician can quickly isolate a fault to a specific board or attached component.

**HIDAS™ Software Utilities**

HIDAS™ node boards/backplanes are connected serially to and from the system's Host Interface Controller (HIC) forming a ring. Each node board in the ring uses a token ring style protocol to provide a deterministic data rate on the bus.

The HIDAS™ software utilities provide various development verification tools:

- **diags** – (Also known as 'hictest'). A utility that provides low-level verification of the HIDAS™ ring, node board configurations, electrical connections, attached I/O component operation, and the operational/error data words generated by the node boards.
- **Xdiag** – Optional Xwindows utility to verify the software and hardware sides of the HIDAS™. Xdiag verifies the complete path from:

*hardware device → node boards → HIC → device driver → data files → API*

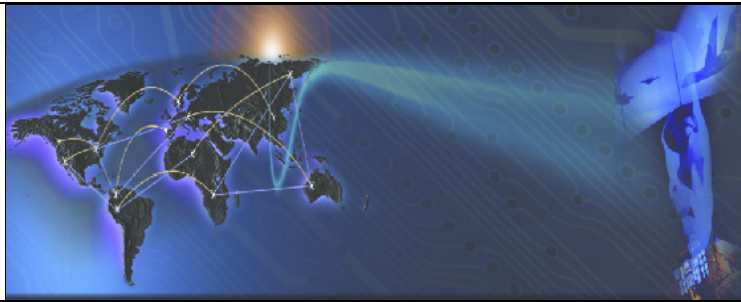

**HIDAS (Cont'd)**

**Auxiliary Function Boards**

COMPRO has several auxiliary circuit boards often used in conjunction with the HIDAS™ node boards. These are independent of the HIDAS™ ring. They solve typical design problems in simulated aircraft cockpits.

• **400 Hz EL Panel Driver**

(6061-000400-009) – Electroluminescent (EL) panels are found in many modern aircraft lighting systems requiring lights with low current use and low heat production. The 400 Hz EL Panel Driver receives a brightness control voltage from 0-10 volts, typically from a HIDAS™ Analog Out, and uses that to control the AC voltage to one or more EL panels.



• **Dimmer Filters**

(6061-000500-xxx) – Simulated cockpit lighting can use Pulse Width Modulated (PWM) adjustable speed drives, normally used for DC motor control, to drive large loads of lamps and LEDs. Since the drives are designed for the load of a motor armature, their output is unstable when there is no load and is generally electrically noisy when driving lamps.

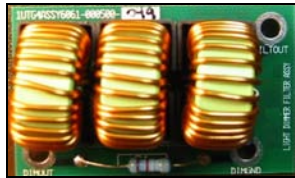

Dimmer Filters provide a load resistance and inductance for stabilizing and filtering the output of the PWM drive. The family includes boards for 5V and 28V lighting and different current capacities.

• **Intensity Translators** (6061-000700-xxx) – The

Intensity Translator family of boards provides signal inversion and translation for various custom applications (for example, a circuit with a potentiometer that needs to increase intensity based on CCW potentiometer rotation).



• **Intensity Controller** (6061-000750-009) – The Intensity Controller board converts a 0-to-10 volt signal into a 0-to-100% duty cycle Pulse Width Modulated (PWM) signal running at a frequency of approximately 50 KHz. The output may be inverted to provide a 100% to 0% duty cycle from a 0-to-10 volt input. The board is capable of sinking up to 1.3 amps continuously at 100% duty cycle, and can drive loads up to 100 volts.



• **Differential Driver**

(6061-001000-009) – The Differential I/O board converts between single ended TTL signals and differential ANSI TIA/EIA 422 B signals for longer distance communications with enhanced reliability and noise immunity. The board provides 8 driver channels converting 5VDC TTL signals to RS 422 signals, and 8 receiver channels converting RS 422 to 5VDC TTL. Optionally, the board can mount in a HIDAS™ backplane for power.

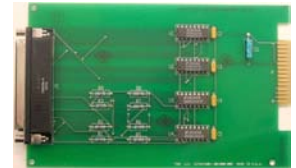





• **Adapters** (6061-0020xx-009) – The adapters attach to the AMPLIMITE end of HIDAS™ node boards and map from the 62-pin AMPLIMITE locking connectors to four or five legacy 10-pin AMPMODU connectors. There is a unique adapter for each node board type. The adapter extends 2 inches (5 cm) from the back of a node board.





HIDAS (Cont'd)

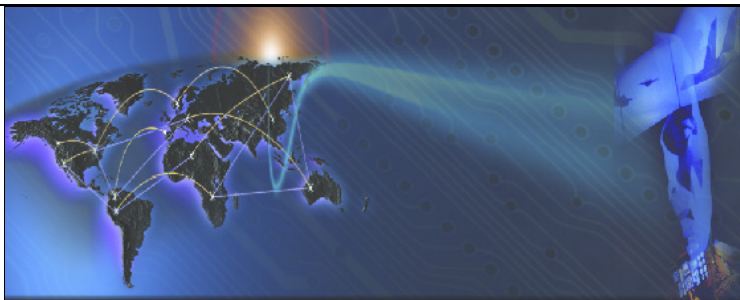

## Component Specifications

Item	Specification(s)
<p><b>Host Interface Controller (HIC) Board</b></p> 	<ul style="list-style-type: none"> <li>• A half-height 32-bit PCI board that conforms to PCI Revision 2.1 Specification, 33 MHz, 5-volt implementation.</li> <li>• Manages the node board communications protocol and transfers 16-bit words to and from the PC memory and the node board ring.</li> </ul>
<p><b>Node Boards:</b></p>	<ul style="list-style-type: none"> <li>• 3U Euroboard form factor (100 cm x 160 cm).</li> <li>• Board thickness of 1.6 mm with 10 mm nominal component height.</li> <li>• Gold-plated board edge connectors.</li> </ul> <p><b>Note:</b> There are five types of node boards available. The newest generation provides 62-pin AMPLIMITE locking connectors; some legacy 10-pin AMPMODU boards are still available. An adapter board is available for legacy applications that have 10-pin wiring but are using the 62-pin boards.</p>
<ul style="list-style-type: none"> <li>• <b>TTL I/O (TIC) Board</b></li> </ul> 	<ul style="list-style-type: none"> <li>• Reads or writes to up to 32 TTL logic devices.             <ul style="list-style-type: none"> <li>– The TTL input board connects up to 32 channels of 5V input from discrete switches.</li> <li>– The TTL output board drives 32 channels of open-collector outputs with either positive or negative logic.</li> </ul> </li> </ul> <p>Options:</p> <ul style="list-style-type: none"> <li>• Two 12-bit serial encoder input channels are options on TTL boards.</li> <li>• The matrix keyboard version supports two 8x8 matrix inputs.</li> </ul>
<ul style="list-style-type: none"> <li>• <b>Display Driver (DDC) Board</b></li> </ul> 	<ul style="list-style-type: none"> <li>• Provides four 8-channel ULN2803A output drivers for up to 32 incandescent lamps, LEDs, or relays. Each of the 32 outputs can sink 100 milliamps at the upper operating temperature of the DDC. Any one channel can sink over 200 milliamps provided the total current consumption of a ULN2803A does not exceed 800 milliamps. Each output is diode-protected from relay spiking.</li> <li>• Includes socketed resistors which provide a small warming voltage for extending an incandescent lamp's filament life. The warming resistors are easily removed for other applications.</li> <li>• Includes a lamp test function that allows all DDC boards on a backplane to be connected to ground via a relay.</li> </ul>
<ul style="list-style-type: none"> <li>• <b>Analog Input (AIC) Board</b></li> </ul> 	<ul style="list-style-type: none"> <li>• Performs 12-bit analog-to-digital conversion on up to eight analog channels. You can configure AICs for bipolar (-V to +V) or unipolar operation (0 to +V) in either 10V or 20V spans.</li> <li>• Performs channel conversion serially, with about 30 microseconds between channel conversions.</li> </ul> <p><b>Note:</b> A 10V precision reference is available for referencing potentiometers and analog instruments.</p>



HIDAS (Cont'd)

Component Specifications (continued)

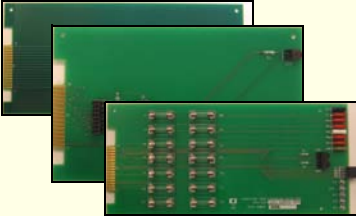
Item	Specification(s)
<ul style="list-style-type: none"> <li><b>Analog Output (AOC) Board</b></li> </ul> 	<ul style="list-style-type: none"> <li>Performs 12-bit digital-to-analog conversion.</li> <li>Can drive up to eight analog instruments or other devices requiring a 0 – 10VDC, low current drive.</li> </ul>
<ul style="list-style-type: none"> <li><b>LCD/LED Driver (LDC) Board</b></li> </ul> 	<ul style="list-style-type: none"> <li>Implements custom serial streams for driving displays and custom serial interfaces.</li> <li>Different types of LDC boards are available: <ul style="list-style-type: none"> <li>LDC-A drives 32 HP HDSP-2000, HCMS-200x, and HCMS-230x series 5x7 dot matrix alphanumeric displays.</li> <li>LDC-B drives 4 groups of twelve 7-segment LEDs.</li> <li>LDC-C drives 16 OSRAM IPD2133 series 5x7 dot matrix alphanumeric displays.</li> <li>LDC-D provides 10 encoded digital angles to a serial avionics interface.</li> </ul> </li> </ul>
<p><b>Test Board Set</b></p> 	<p>Provides three specialty HIDAS™ test and diagnosis boards:</p> <ul style="list-style-type: none"> <li>The Extender board extends a node board out of the backplane's chassis so that board connector pins and components can be easily reached.</li> <li>The Loop Passer board provides backplane continuity while a node board is removed for repair.</li> <li>The Backplane Tester board provides test point connections for backplane power, lamp test wiring, and data and clock timing signals.</li> </ul>
<p><b>Cabling</b></p>	<p>Data cabling between backplanes and between a backplane and the link controller is four conductors, twisted pair, CAT5 data cable with RJ-45 connectors.</p> <p><b>Note:</b> The pair twisting is NOT identical to Ethernet definitions. Standard Ethernet patch cables can be used for short distances but are not recommended for longer runs.</p>
<p><b>Software Driver</b></p>	<ul style="list-style-type: none"> <li>The PCI HIC board has a driver for Linux® Kernel 2.6 versions. It has been successfully used with SUSE®, Red Hat®, Fedora™ Core, and Mandriva distributions.</li> <li>Also includes diagnostic software for board calibration and maintenance.</li> </ul>
<p><b>Software Application</b></p>	<p>Optional Real Time I/O (rt_io™) software system that is compatible with the HIDAS™ I/O system and which provides Ethernet or Reflective memory communication to other Host applications. rt_io™ provides execution rate scheduling, engineering unit conversion, additional software debugging and diagnostic tools, and optional interfaces to MIL-STD-1553 and ARINC 429 interface devices.</p>
<p><b>Documentation</b></p>	<p>Distributed with the <i>HIDAS Design and Maintenance Manual</i>, which provides the theory of operations, circuit board details, and software operation.</p>

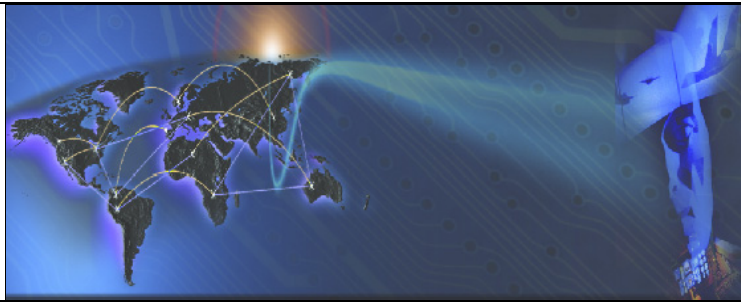

HIDAS (Cont'd)

## Ordering Information

Part Number	Description
6061-003010-009	TIC-A board, 32 TTL IN; AMPLIMITE Locking
6061-003010-019	TIC-B board, 32 TTL OUT – Positive; AMPLIMITE Locking
6061-003010-029	TIC-C board, 32 TTL IN and Two 12 Bit Encoder In; AMPLIMITE Locking
6061-003010-039	TIC-D board, 32 TTL OUT and Two 12 Bit Encoder In; AMPLIMITE Locking
6061-003010-049	TIC-E board, 16 TTL IN & 16 TTL OUT or 2 8x8 Matrix; AMPLIMITE Locking
6061-003010-069	TIC-G board, 32 TTL OUT-Negative; AMPLIMITE Locking
6061-003020-009	AIC board, 8 Analog IN; AMPLIMITE Locking
6061-003030-009	AOC board, 8 Analog OUT; AMPLIMITE Locking
6061-003040-009	DDC board, 32 Display Driver OUT; AMPLIMITE Locking
6061-000300-001	LDC-A board, 32 5x7 Matrix Alphanumeric LEDs; 5x10 AMPMODU
6061-000300-002	LDC-B board, 4 banks of 12 7-Segment LEDs; 5x10 AMPMODU
6061-000300-003	LDC-C board, 16 5x7 Matrix Alphanumeric LEDs; 5x10 AMPMODU (ALE-47 DCU)
6061-000300-004	LDC-D board, custom Resolver Serial Interface; 5x10 AMPMODU (EA-6B 89A Antenna Bearing)
6061-000300-005	LDC-A board, with extended character set
6061-000300-305	LDC-A board, with enhanced character set (includes extended and inverse characters) <b>Note:</b> This board supersedes part numbers 6061-000300-105 and 6061-000300-205.
6061-000310-009	LED Interface board
6061-000400-009	400 Hz EL panel driver board, 115VAC
6061-000500-009	Dimmer Filter (5 volts; 1-8 amps)
6061-000500-019	Dimmer Filter (28 volts; 1-8 amps)
6061-000500-029	Dimmer Filter (5 volts; 9-16 amps)
6061-000500-039	Dimmer Filter (28 volts; 9-16 amps)
6061-000500-049	Dimmer Filter (5 volts; 17-29 amps)
6061-000700-xxx	Intensity Translator, where xxx= <ul style="list-style-type: none"> <li>• 009 – Type A</li> <li>• 019 – Type B</li> <li>• 029 – Type C</li> <li>• 039 – Type D</li> <li>• 049 – Type E</li> </ul>
6061-000750-009	Intensity Controller
6061-001000-009	Differential I/O driver board
6061041-003	9-slot backplane
6061-000200-001	PCI Bus Link Controller and Linux <sup>®</sup> driver; includes diagnostic software

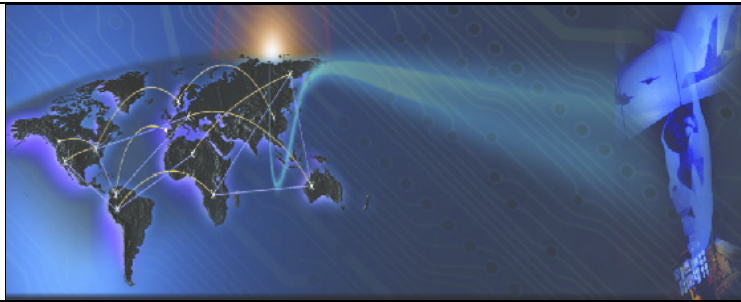

**HIDAS (Cont'd)**

**Ordering Information (continued)**

Part Number	Description
6061-002010-009	Cable adapter, TIC AMPLIMITE board to AMPMODU wiring
6061-002020-009	Cable adapter, AIC AMPLIMITE board to AMPMODU wiring
6061-002030-009	Cable adapter, AOC AMPLIMITE board to AMPMODU wiring
6061-002040-009	Cable adapter, DDC AMPLIMITE board to AMPMODU wiring
6061-002050-009	Cable adapter, LDC AMPLIMITE board to AMPMODU wiring
6061-002060-009	Cable adapter, DIO AMPLIMITE board to AMPMODU wiring
6061-0005-HIT	Test board set: <ul style="list-style-type: none"> <li>• Extender (6061-000900-009)</li> <li>• Backplane Tester (6061-000910-009)</li> <li>• Loop Passer (6061-000920-009)</li> </ul>
3572-C10009	Card cage, cooling fan, and modular power supplies sized for your custom application
rtio-001	Custom real-time I/O software application system with: <ul style="list-style-type: none"> <li>• engineering unit conversion</li> <li>• advanced development tools</li> <li>• Ethernet<sup>®</sup></li> <li>• reflective memory (MIL-STD-1553)</li> <li>• ARINC 429 interfaces</li> </ul>

- a. Contact COMPRO for the current price of each component. All prices are FOB, Melbourne, Florida. Taxes are applied to sales as required by the State of Florida and the U.S. Federal Government. Payment is due on receipt.
- b. Please call for a quotation based on exact quantities. For planning purposes a typical flight training device uses 15 AOCs, 10 AICs, 35 TICs, 15 DDCs, and 9 backplanes.
- c. Delivery is 4 – 12 weeks ARO depending on board type and quantity in stock.



**COMPRO**  
 COMPRO Computer Services, Inc.  
 Tel: (800) 936-2673  
 www.compro.net



**HIDAS (Cont'd)**

**General Specifications**

Item	Specification(s)
<b>Operating Temperature</b>	32° F to 126° F (0° C to +52° C)
<b>Operating Humidity</b>	10% to 90% non-condensing
<b>Non-Operating Temperature</b>	-58° F to 158° F (-50° C to +70° C)
<b>Non-Operating Humidity</b>	90% non-condensing maximum
<b>Sampling Rate</b>	The HIDAS™ samples all node boards every 10 milliseconds. For HIDAS™ to detect an event, it must persist for at least 10 milliseconds.
<b>Design Standard</b>	The HIDAS™ printed circuit boards are designed to MIL-STD-275.
<b>Maximum Distance</b>	The maximum guaranteed operating distance between the link controller and a backplane or between adjacent backplanes is 250 feet (76.2 meters).
<b>Power Requirements</b>	<ul style="list-style-type: none"> <li>• Each HIDAS™ node board requires a +5VDC logic power supply.</li> <li>• The LDC interface board requires +5VDC and +15VDC.</li> <li>• Analog Input and Analog Output boards each require an additional ±15VDC.</li> <li>• The Display Driver board defaults to +28VDC operation, but may be set up to interface with components whose operating voltage is anywhere from +5VDC to +31VDC.</li> <li>• The HIDAS™ backplane provides power distribution to all node boards residing in it.</li> </ul>



**COMPRO Computer Services, Inc.**  
 105 East Drive  
 Melbourne, Florida U.S.A.  
 Tel: (800) 936-2673  
 www.compro.net



**INTERNATIONAL BUSINESS PARTNERS**



**Brazil**  
**Flight Simulator System, Ltda.**  
 Tel: +55 (12) 3322-0470  
 www.flightsimulatorsystem.com

**Italy**  
**Encore Real Time Computing S.r.l.**  
 Tel.: +39 0362 300433  
 www.encore.it

**United Kingdom**  
**COMPRO Services Ltd.**  
 Tel.: +44 (0) 1252 852228  
 www.compro-uk.com

**France**  
**Encore Real Time Computing, S.A.**  
 Tel.: +33 1 30 23 36 00

**Germany**  
**Encore Real Time Computing GmbH**  
 Tel.: +49 21 31 92 43 32

**Spain**  
**Encore Real Time España S.A.**  
 Tel.: +34-981-288404

**Japan**  
**Japan Encore Computer, Inc.**  
 Tel.: +81-3-5791-4940